

1116SLD Conductivity meter Operation Manual



Chapter 1. Introduction

Model 1116 SLD is 4 terminal DC electric conductivity meter. A measurement of resistance is to detect voltage drop between a limited distance to be passed by analytical sample under a constant current. The connection point between electrical source and analytical sample is called as electrical terminal, and the terminal to measure voltage drop is called as voltage terminal. 4 terminal measurement is used by electric and voltage terminal separately.

Features

1. Compact design
2. Economical apparatus
3. A sensitivity range from 200m Ω to 200 mega Ω
4. Easy operation
5. Sample like Polymer to solid material are possible to be measured.

Specifications

Size:	25 cm (w) x 20 cm (d) x 6.5 cm (h)
Weight:	4 Kg
Rotational Range:	200m Ω , 2, 20, 200 Ω , 2, 20K Ω , 200K Ω , 2, 20, 200M Ω
Precision:	$\pm 1\%$ FS
Display:	-1999 \sim 0 \sim +1999
Output:	0 \sim +2 V
Power:	220 VAC
Operating Temperature:	10 to 50 centi degree

Accessories

Standard

Power Cord
Cell cable
1116SLD Operations Manual

Option

4 Contact probe
Conductivity film electrode

Chapter 2. General Information

User updates After receiving product update information news, the valuable information related to this and other ALS products, please register your e-mail address at our local distributors. We would like to know who you are, and what your interests are with regard to electroanalysis.

Technical changes We reserve the right to make technical changes to improve the instrument without notice.

Damaged shipment Breakage of any part of this instrument during shipping should be reported immediately to the freight handler and ALS Customer service.

It is necessary to keep the original packing box and contents for inspection by the freight forwarder. ALS will replace any new instrument damaged in shipping with an identical product as expediently as possible after the claim filing date. Claims not filed within 7 days after shipping may be invalid.

Do not return damaged goods to ALS. Please contact with your local distributor informing about its damaged status.

They will contact with our service department.

Product warranty ALS Co., Ltd warrants equipment manufactured by the company to be free from defects in material and workmanship for a period of 90 days from the date of shipment. This assumes normal usage under commonly accepted operating parameters. ALS agrees to either repair or replace, and free of part charges to the buyer, any parts of such instrumentation which, under proper and normal conditions of use, prove to be defective within 90 days from date of shipment. Electrochemical cells and working electrodes are warranted for 30 days.

ALS neither assumes nor authorizes any person to assume for it any other liability in connection with the sale, installation, service, or use of its instrumentation.

All products manufactured by ALS are tested and inspected prior to shipment. Upon prompt notification by the buyer, ALS will correct any defects in warranted equipment of its manufacture either (by our option) by return of the item to our factory, or shipment of a repaired or replacement part. ALS will not be obliged, however, to replace or repair any piece of equipment which has been abused,

improperly installed, altered, damaged or repaired by others. Defects in equipment do not include decomposition, wear, or damage by chemical action or corrosion.

This instrument is manufactured, either wholly or in part, for research purposes only. Use in medical diagnosis is not intended, implied or recommended by the manufacturer. The accountability for usage toward this purpose rests entirely with the user.

Limited obligations covered by this warranty include:

In the case of instruments not of ALS manufacture, the original manufacturer's warranty applies.

Shipping charges under warranty are covered only in one direction. The buyer is responsible for shipping charges to the factory, if return of the part is required.

Expendable items including disposable items such as working electrode, reference electrodes, source lights, panel lights, fuses, etc. are excluded from the warranty.

Service information

ALS provides a skilled service staff to solve your equipment oriented problems. For further details, please contact by e-mail (service@bas.co.jp or BXS00263@nifty.ne.jp). Following discussion of your specific difficulties, an appropriate course of action will be described and the problem resolved accordingly.

Please contact with local distributor and describe to them the problem you are having in full detail. They obtain a RETURN AUTHORIZATION NUMBER (RA#). The RA# identifies you as the sender. All correspondence and shipments should be sent to ALS.

Chapter 3 Installation

INSPECTION OF SHIPMENT After unpacking the instrument carefully, check the package contents and inspect for breakage. Table 1 lists the parts of the 1116SLD. This list is subject to change. Please refer to the packing slip with your instrument. Assembly of these various parts will be outlined in the following chapters.

Please retain the shipping box and packing material until you have fully tested the unit to be certain that no damage was incurred during shipping.

If a shortage exists, please contact with local distributor or ALS Customer Service and describe the shortage. A replacement part will be sent immediately subject to stock availability.

Table 1. Model 1116SLD Package list

Model 1116SLD Main body
Cell cable
Instruction manual
Warranty card

Place to Setup Model 1116SLD

1. Provide a surge-free power source. Other laboratory equipment such as ovens, vortex mixers, centrifuges, and large motors may cause spikes in the power supply.
2. Make sure that all components of the system share the same ground circuit. This can best be accomplished by plugging all components into a multi-outlet power strip. Plugging the components into independent outlets can produce ground loops, which can produce baseline noise.
3. Locate the Model 1116SLD on a stable bench without vibrations.
4. Select a room where temperature remains stable throughout the day. Avoid installing the Model 1116SLD near windows, air ducts, ovens, and refrigerators. A water-jacketed cell may be required for very precise work.
5. Place the Model 1116SLD away from busy, congested areas. Remote, isolated areas are best for high-sensitivity work.
6. Avoid very dry areas and areas that are carpeted. Static electricity can affect instrument performance. Anti-static floormats and benchmats are useful if spiking caused by static charge is a problem.
7. Avoid areas where radio-frequency interference is likely. Beeper-type pager can be a problem in some installations.

POWER REQUIREMENTS

The Model 1116SLD can be used with 220V (50-60 Hz) power supply. It can be used any place without any modification.

Power Cord Connection

The power cord was fixed in the back-panel (See Figure 1). After making this connection, make certain the power on/off switch is in the certain position. This switch is labeled with a “OFF” and “ON”. When in “OFF” position, the power is off and when in “ON”, the power is on(See Figure 2).

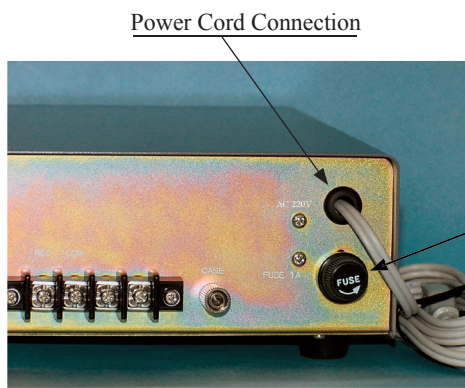

Figure 1. Power cord

Power Cord Connection

Fuse replacement

The fuse is located under power cord connector. Pull fuse holder, and check whether it works or not. If it does not work, it should be replaced with new one.



Figure 2. Model 1116 SLD Front panel

1. Power ON/OFF

It works under 220 ACV. If you want to use it, its cable is plugged into 1116SLD rear panel(please look at its figure).

2. Display

-1999 ~ 0 ~ +1999 figure is displayed into front panel. If its value is over 1999, left side value of 4 digit number is appeared.

The decimal points are decided by sensitivity range.

3. Range

Selection of sensitivity.

Range(Ω)	200m	2	20	200	2k	20k	200k	2M	20M	200M
Current	100mA	10mA	10mA	10mA	1mA	100 μ A	10 μ A	1 μ A	100nA	10nA
Precision	1%	1%	0.50%	0.50%	0.50%	0.50%	0.50%	1.00%	2.00%	2.00%

4. Polarity

A polarity of current is reversed by this switch.

When the contact between detection terminal and sample is not ohmic, uncertain voltage drop may occur. In that case, average of the measurement under both polarity by turn of the switch should give precise result.

Back Panel and Connections

5. Cell Cable

Cell cable connector is used by JMR1610MG

6. Record terminal

REC: When 1000 was displayed on the front panel, its value was converted to 1000 mV as output voltage under resistance measurement.

COM: Standard point (0V)

7. Ground terminal (CASE)

Chassis and standard point of electric circuit are connected with ground terminal, and it is used as ground.

8. Fuse: AC 220V, 1A 6.4 ϕ ×30 l mm

9. Power: 220ACV, 50-60Hz



Figure 3. Back Panel

Cable connector assignment Each of cell cables correspond to cell connector pin.

Cell cables is required to connect the Model 1116SLD to measure sample resistance using custom made probe or commercial probes. The following scheme is shown by standard use.

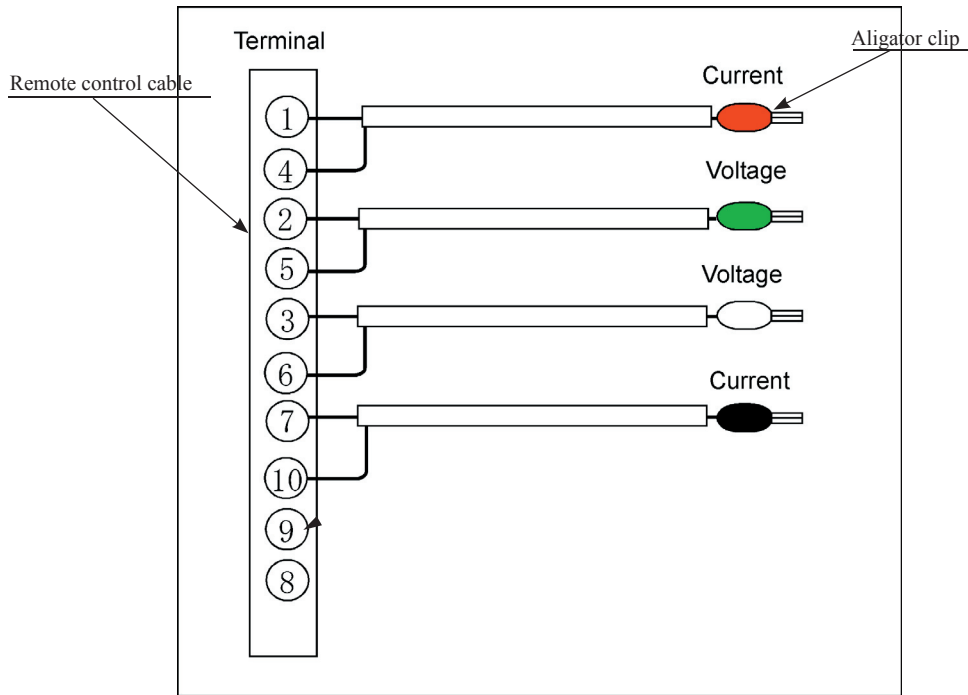

Figure 4. Cable connector assignment.



Figure 5. Contact probe cable (option)

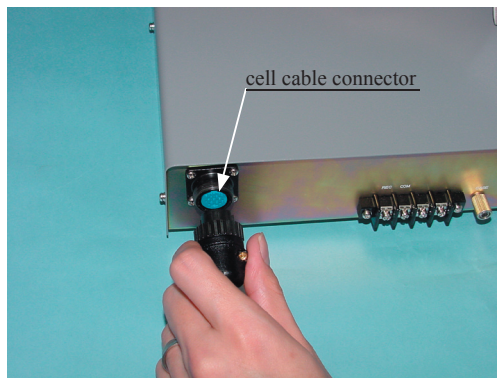

Figure 6. Cell Cable connector.

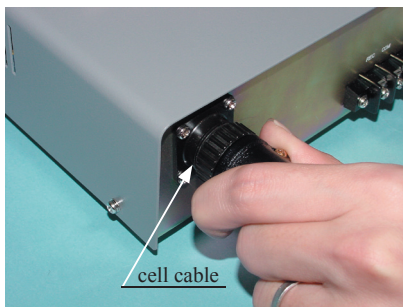

Figure 7. Cell Cable connection.

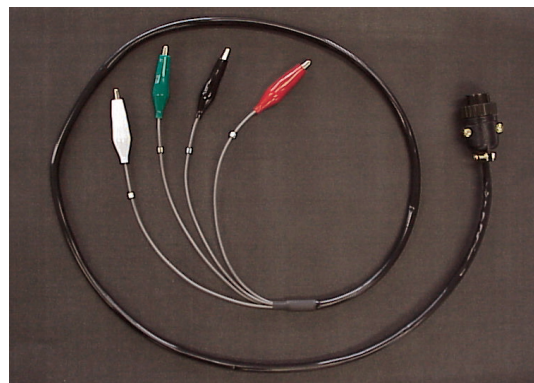

Figure 8. Standard cell cable.

Initial Instrument Operation

With all front and back panel connections made, follow the procedure below for the initial use. (Requires connection to Model 1116 SLD)

1. Cell cable is plugged into the cable connector and tightened firmly.
2. Each alligator clip is connected with probe to measure samples such as polymer, solid and film resistance..
3. Push the front panel power switch to the ON position.
4. Probe contacts with surface of sample, and select range switch. You may have check its resistance from high value to low.
5. If you do not have a constant resistance, please change current polarity switch is reversed. Current polarity is changed to alternate direction, and measure its voltage.
6. If sample has high ohmic contact between probe and sample, its voltage drop may be happened, so it is necessary to use current polarity switch, and measure thier voltages. Their measured values should be made by average.
7. Clean probe contact pin carefully, because if it is corroded, its resistance is changed.



Figure 9. Resistance of Glassy carbon thin plate is measured by contact probe.

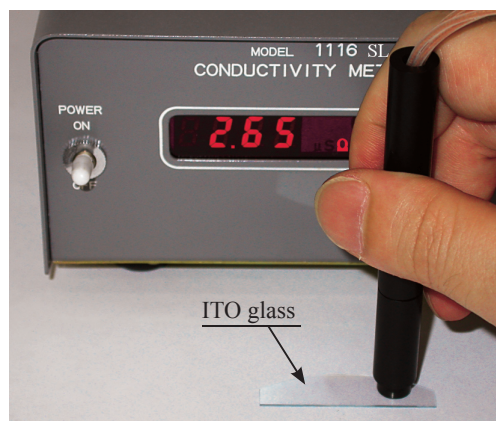

Figure 10. Resistance of ITO glass plate is measured by contact probe.

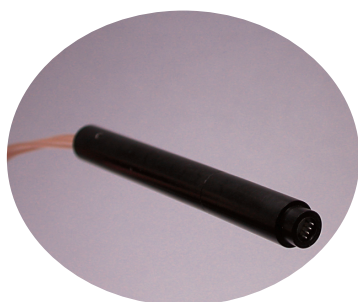

Figure 11. Contact probe.

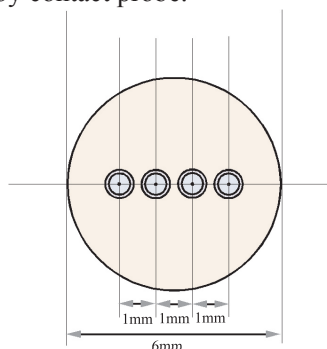

Figure 12. Schematic figure of contact probe.

Maintenance

General Maintenance

The Model 1116SLD is a very rugged instrument and, with proper care, should give years of service.

The following is a brief list of cautions and general maintenance considerations that will extend the lifetime of the instrument.

1. Follow customary, good laboratory practices.
2. Clean all spills, especially salt solutions, on or near the cabinet immediately.
3. Avoid placing the unit in a corrosive atmosphere.
4. Avoid dropping, shaking, or other forms of mechanical abuse to prevent loosening of components or subassemblies.
4. Clean gas lines (rinse and wipe dry) after use.
5. Do not bend the auxiliary electrode when removing or placing the cell vial. Repeated bending will cause the wire to break.

Changing the Contact probe

DO NOT BEND! Be careful and slowly - you should feel the contact pin compress against sample material.

● Conductivity electrode

Platinum is sputtered onto quartz glass to measure potential difference between electrodes, and check electrification. The distance between electrodes is shown in the below figure. When electrode terminals are selected, their electrode distance is changed. If the conductive polymer by chemical doping transits from insulator to metal, its conductivity is measured by in-situ 4 terminal DC conductive measurement, therefore the insulator in low doping region is measured by 2 terminal method, and the metal in high doping region by 4 terminal method.

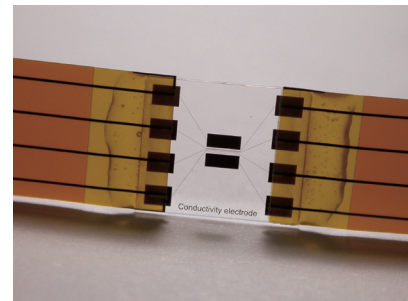

Structure for film electrode

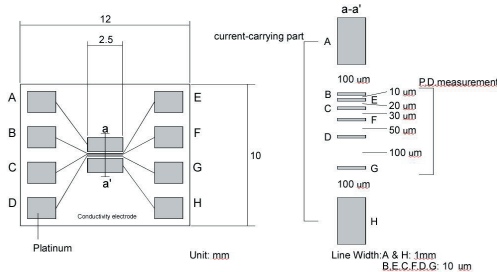

A ~ H is terminal connection.

Terminal gap

Terminal	A	B	C	D	E	F	G	H
A	-	-	-	-	-	-	-	-
B	-	40	140	10	80	250	-	-
C	-	40	90	20	30	200	-	-
D	-	140	90	120	50	100	-	-
E	-	10	20	120	60	230	-	-
F	-	80	30	50	60	160	-	-
G	-	250	200	100	230	160	-	-
H	-	-	-	-	-	-	-	-

unit: μm

Cat No.	Product and description
011315	Conductivity electrode